

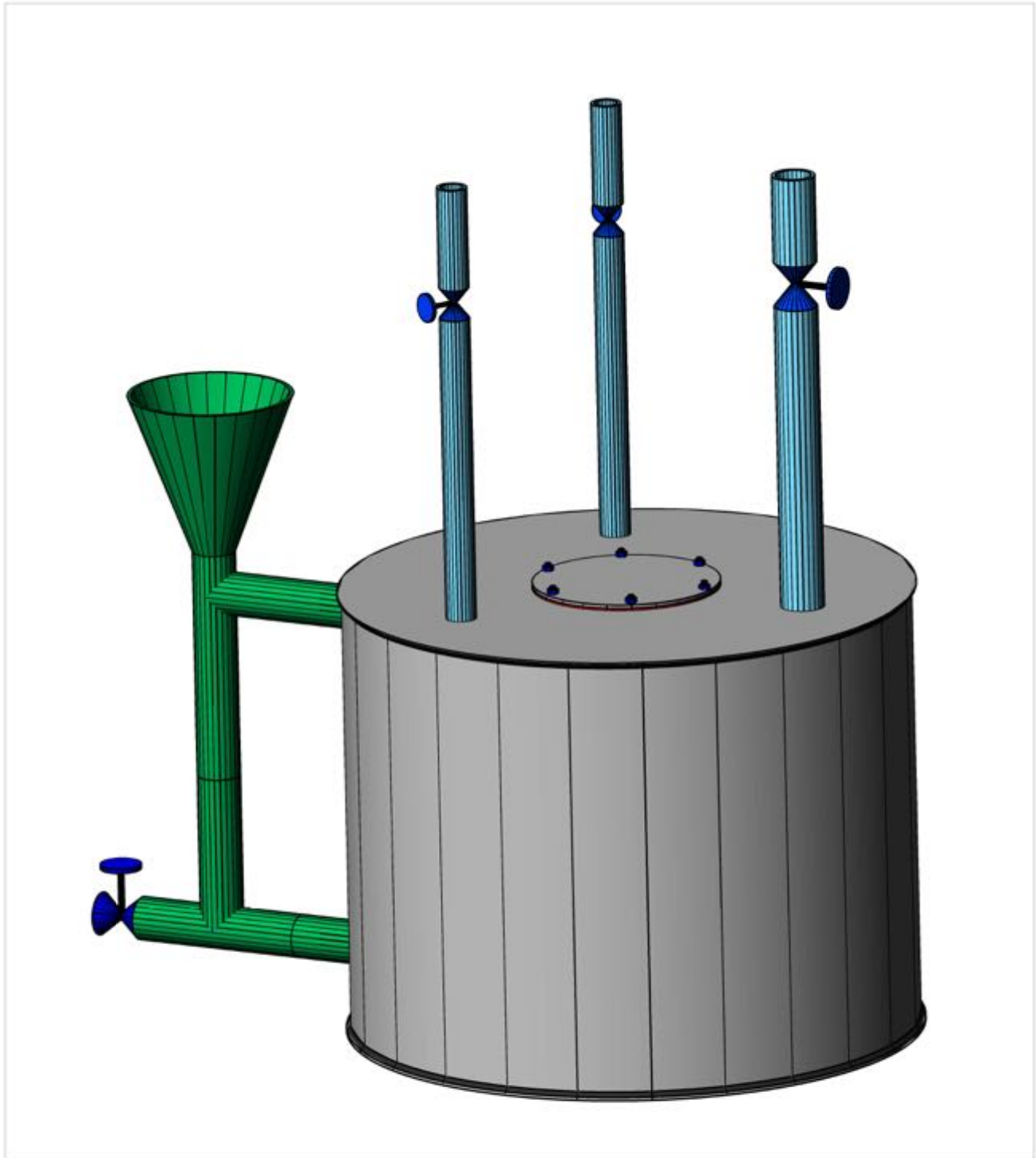



1	2	3	4
RevNo	Revision note	Date	Designed
			Checked
			Approved

VUE TRIDIMENSIONALE





Itemref	Quantity	Title/Name, designation, material, dimension etc			Article No./Reference
Designed by A. Carrea	Checked by E. Arato	Approved by - date Pongiglione - 30/06/08	File name Genvap	Date 30/06/08	Scale N/A
 PS76 ONLUS	 AMIGOS DA GUINE-BISSAU	 DICAT UNIGE	Chaudière		
			010-1-I-GDV-DGC-A	Edition 0	Sheet 1/9

	1	2	3	4
RevNo	Revision note		Date	Designed
				Checked
				Approved

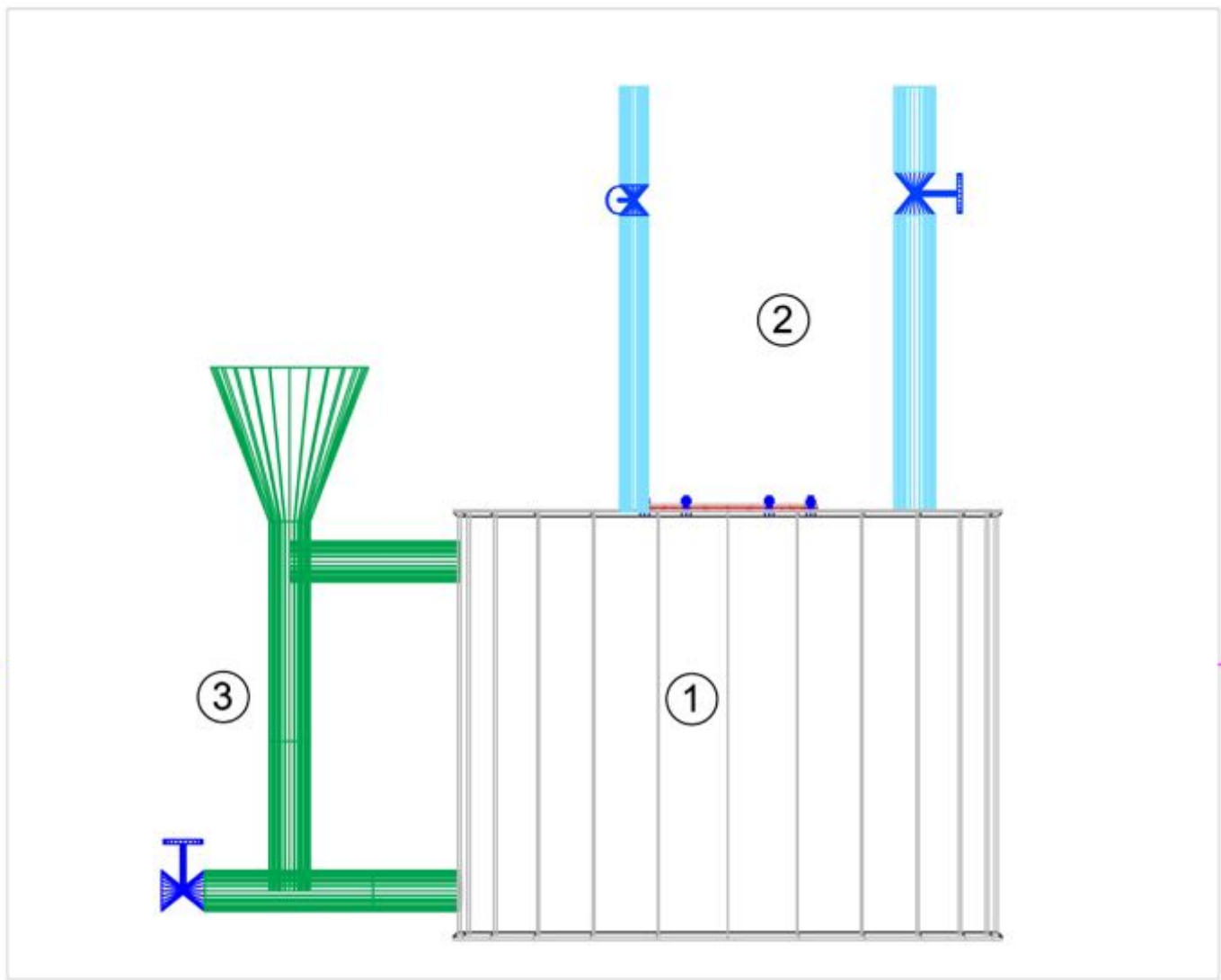
VUE LATÉRALE







ARTICLE	QUANTITE'	DESCRIPTION	NOTES
1		Placage (feuille calandree)	Voir feuille 5
2		Sortie du vapeur	Voir feuille 7
3		Drainage, nivellement et remplissage	Voir feuille 8

Itemref	Quantity	Title/Name, designation, material, dimension etc			Article No./Reference	
Designed by A. Carrea	Checked by E. Arato	Approved by - date Pongiglione - 30/06/08	File name Genvap	Date 30/06/08	Scale 1:8	
 PS76 ONLUS	 AMIGOS DA GUINE-BISSAU	 DICAT UNIGE	Chaudière			
			010-1-I-GDV-DGC-A			Edition 0

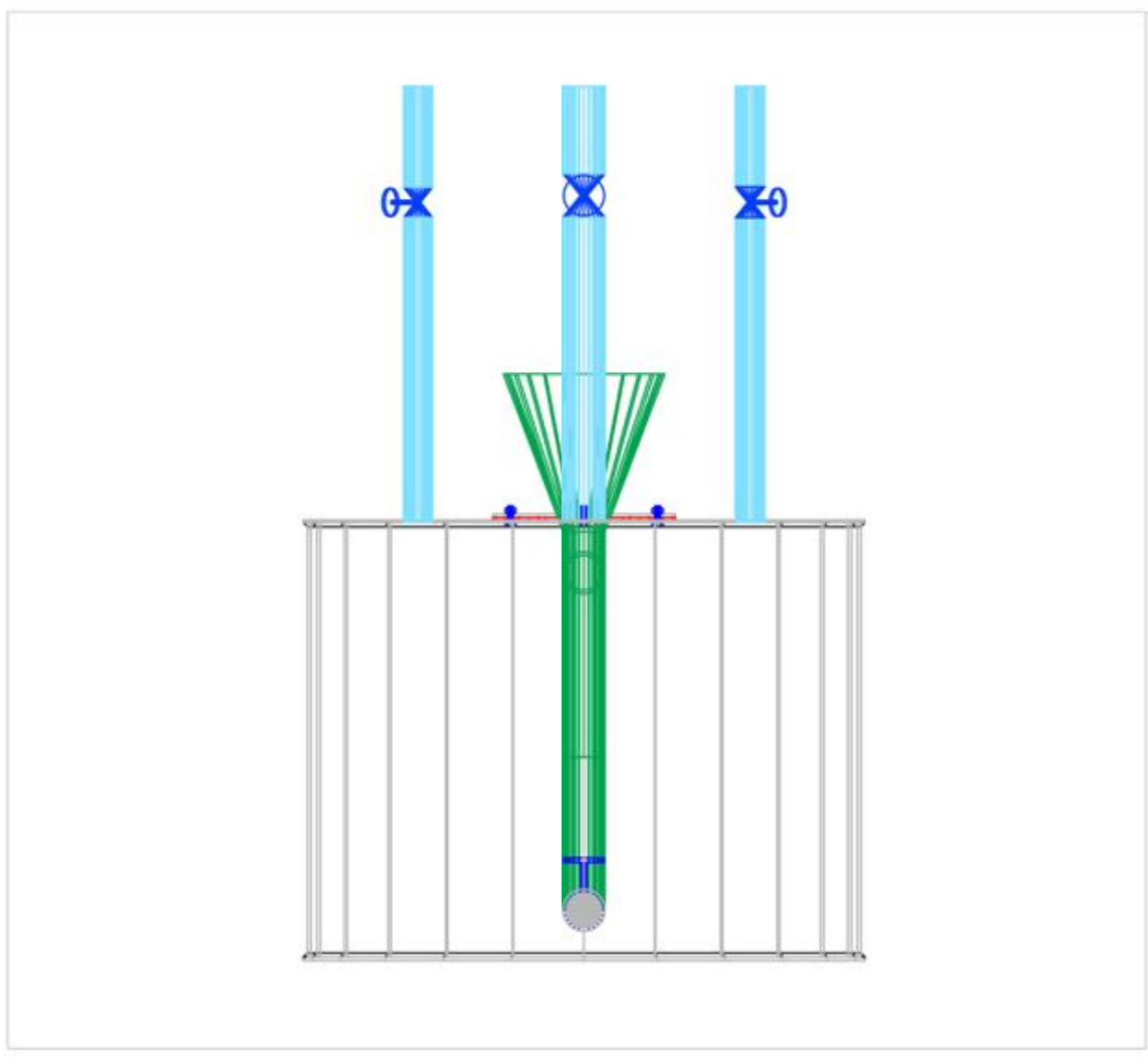
1	2	3	4
RevNo	Revision note	Date	Designed
			Checked
			Approved

VUE FRONTALE



Itemref	Quantity	Title/Name, designation, material, dimension etc			Article No./Reference	
Designed by A. Carrea	Checked by E. Arato	Approved by - date Pongiglione - 30/06/08	File name Genvap	Date 30/06/08	Scale 1:8	
 PS76 ONLUS	 AMIGOS DA GUINE BISSAU	 DICAT UNIGE	Chaudière			
			010-1-I-GDV-DGC-A	Edition 0	Sheet 3/9	

1	2	3	4
RevNo	Revision note	Date	Designed
			Checked
			Approved

VUE PAR HAUT

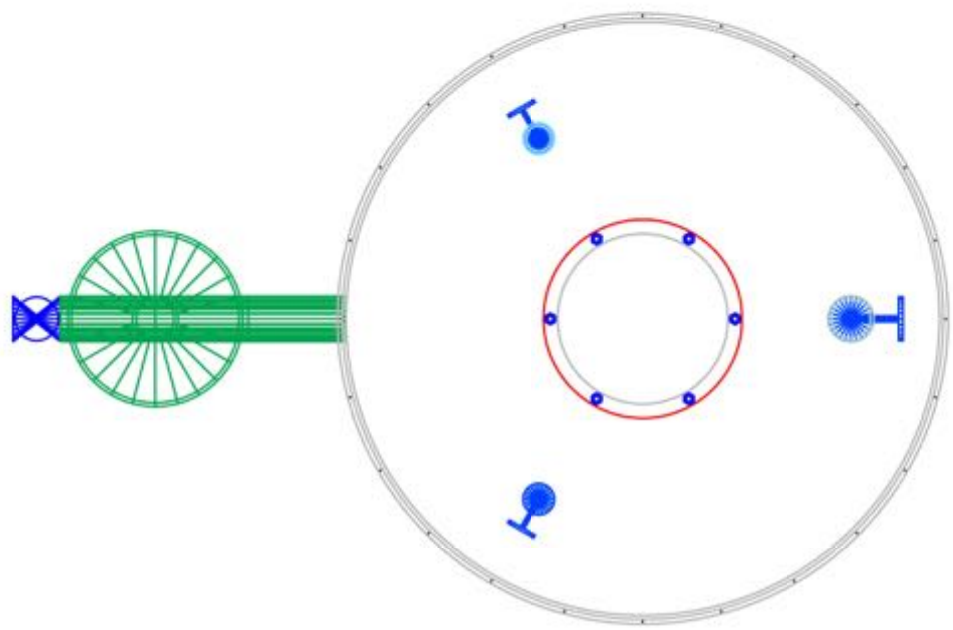



Itemref	Quantity	Title/Name, designation, material, dimension etc			Article No./Reference	
Designed by A. Carrea	Checked by E. Arato	Approved by - date Pongiglione - 30/06/08	File name Genvap	Date 30/06/08	Scale 1:8	
	PS76 ONLUS			Chaudière		
				010-1-I-GDV-DGC-A	Edition 0	Sheet 4/9

1	2	3	4		
RevNo	Revision note	Date	Designed	Checked	Approved

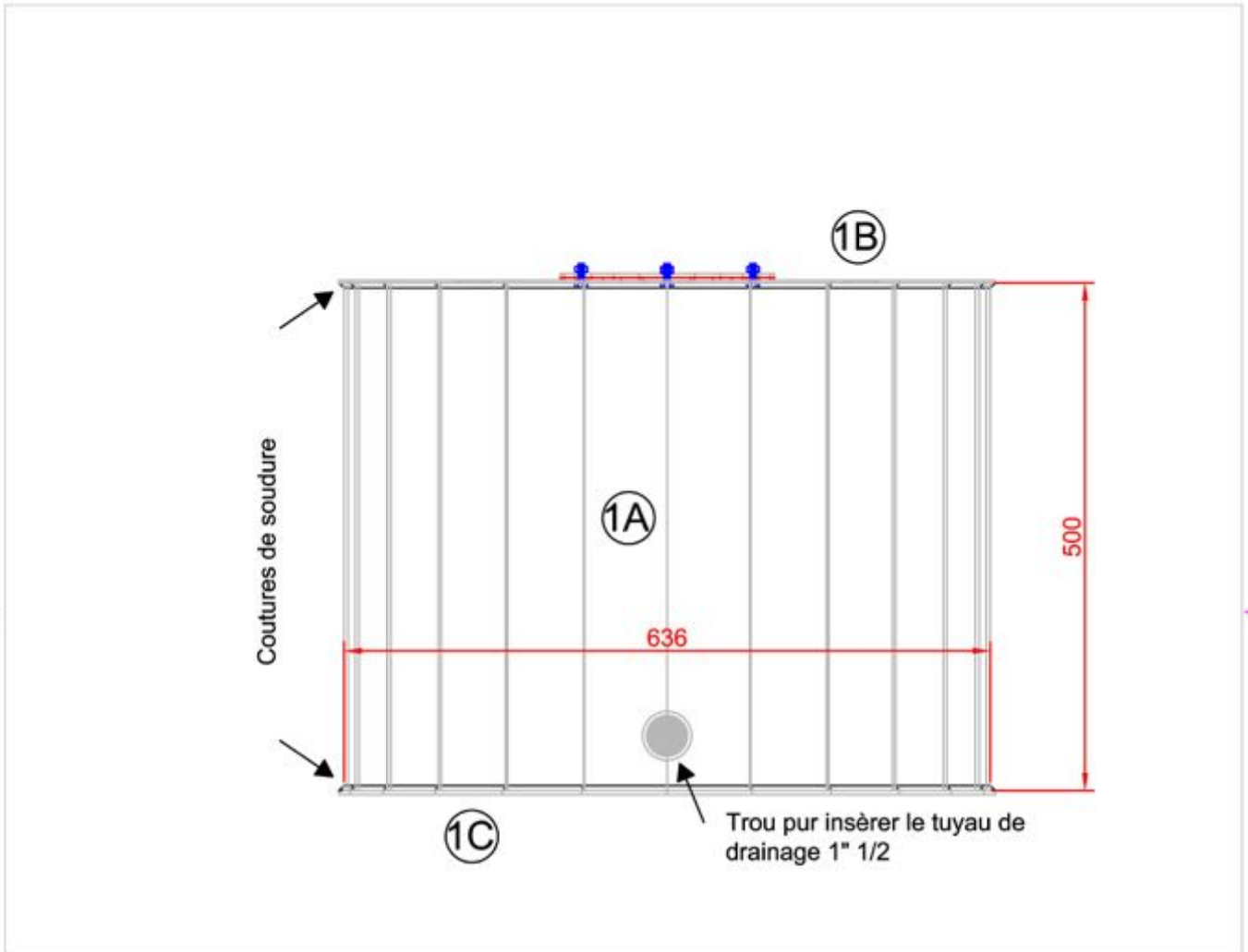
PLACAGE



ARTICLE	QUANTITE'	DESCRIPTION	NOTES
1A	1	PLACAGE	Acier épaisseur 2,5 mm
1B	1	Couverture	Voir feuille 6
1C	1	Fond	Acier épaisseur 2,5 mm

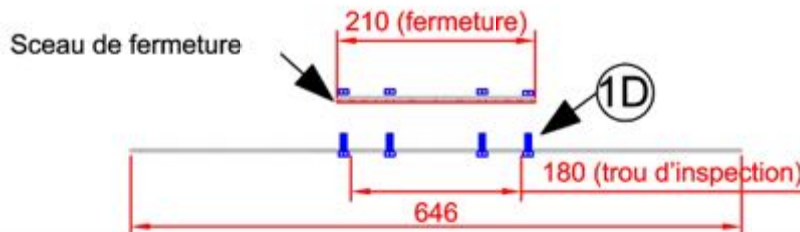
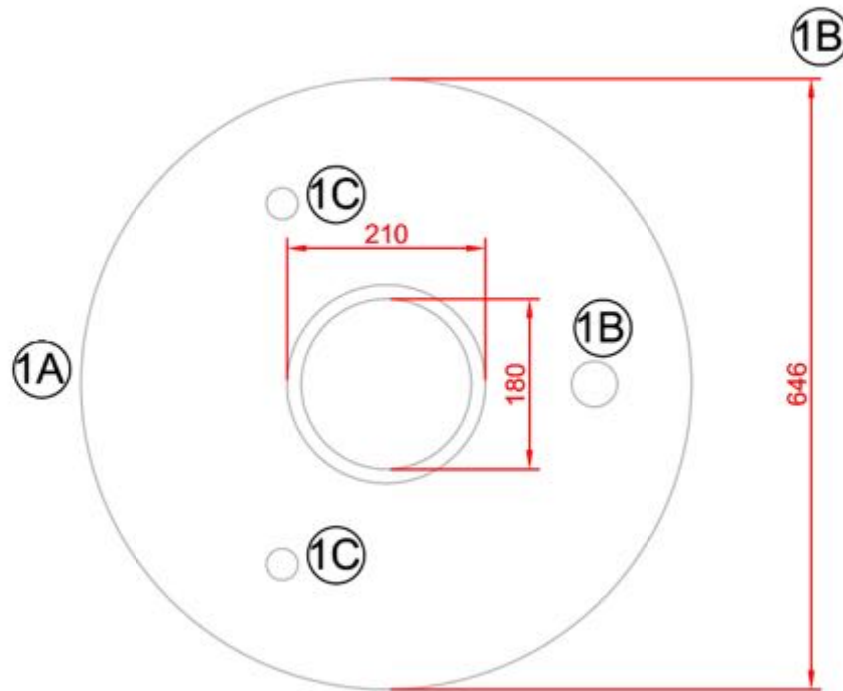

Itemref	Quantity	Title/Name, designation, material, dimension etc			Article No./Reference	
Designed by A. Carrea	Checked by E. Arato	Approved by - date Pongiglione - 30/06/08	File name Genvap	Date 30/06/08	Scale 1:8	
 PS76 ONLUS	 AMIGOS DA GUINE BISSAU	 DICAT UNIGE	Chaudière			
			010-1-I-GDV-DGC-A			Edition 0

COUVERCLE



ARTICLE	QUANTITE'	DESCRIPTION	NOTES
1A	1	Couvercle	Acier épaisseur 2,5 mm
1B	1	Trou pour tuyau 1 "1/2	
1C	2	Trou pour tuyau 1 "	
1D	6	Boulons M6	Note 1



Note 1: La tête des boulons doit être soudée sur la face inférieure du couvercle avant de le souder au placage

Itemref	Quantity	Title/Name, designation, material, dimension etc			Article No./Reference		
Designed by A. Carrea	Checked by E. Arato	Approved by - date Pongiglione - 30/06/08	File name Genvap	Date 30/06/08	Scale 1:8		
 PS76 ONLUS		 AMIGOS DA GUINE-BISSAU		 DICAT UNIGE		<h2>Chaudière</h2>	
010-1-I-GDV-DGC-A				Edition 0	Sheet 6/9		

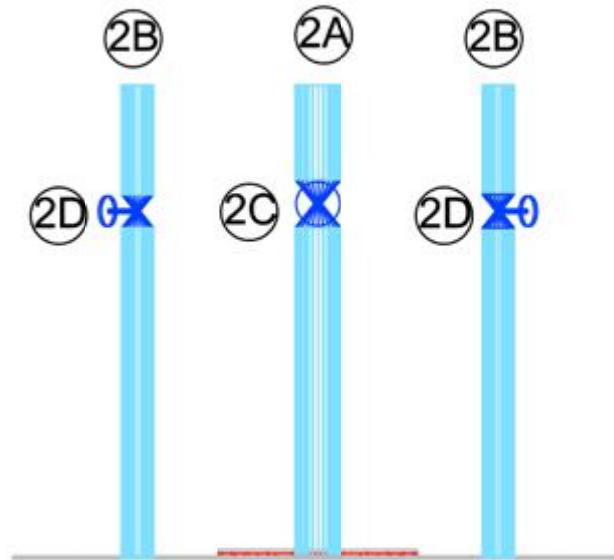
SORTIE VAPEUR



ARTICLE	QUANTITE'	DESCRIPTION	NOTES
2A	1	Tuyau 1" 1/2	Pour connecter la vapeur au stérilisateur
2B	2	Tuyau 1"	un pour connecter la vapeur au clarificateur et l'autre pour l'évent de la vapeur
2C	1	Vanne 1" 1/2	vanne tournante sphérique
2D	2	Vanne 1"	vanne tournante sphérique

Itemref	Quantity	Title/Name, designation, material, dimension etc			Article No./Reference	
Designed by A. Carrea	Checked by E. Arato	Approved by - date Pongiglione - 30/06/08	File name Genvap	Date 30/06/08	Scale 1:8	
 PS76 ONLUS  AMIGOS DA GUINE BISSAU  DICAT UNIGE	Chaudière				Edition 0	Sheet 7/9
	010-1-I-GDV-DGC-A					

1	2	3	4
RevNo	Revision note	Date	Designed
			Checked
			Approved

A ÉLÉMENTS POUR REMPLISSAGE, DRAINAGE ET NIVEAU A

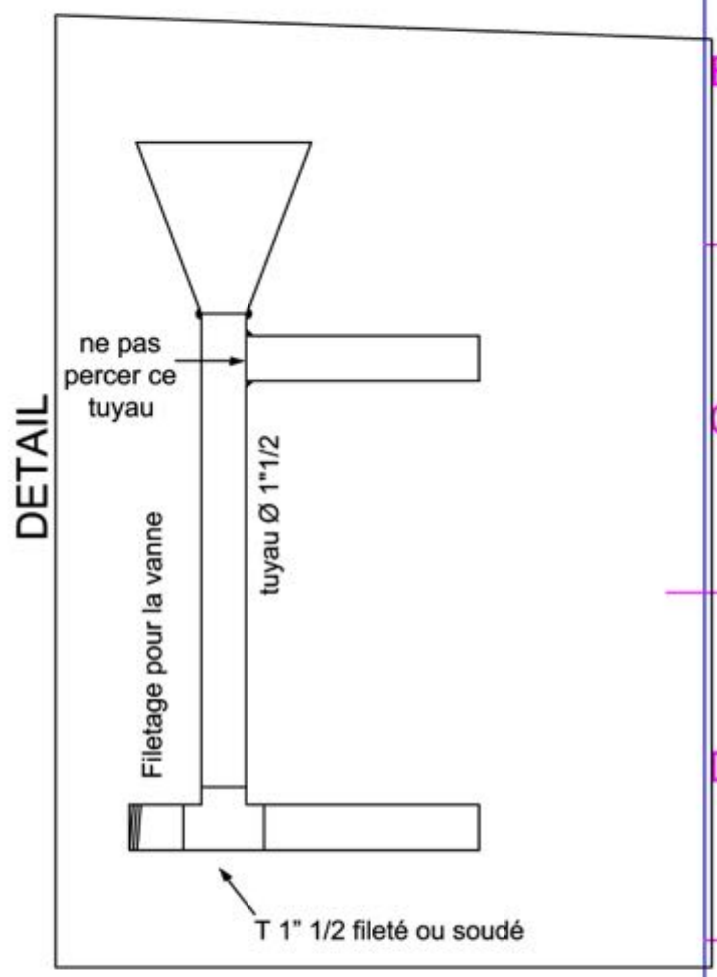
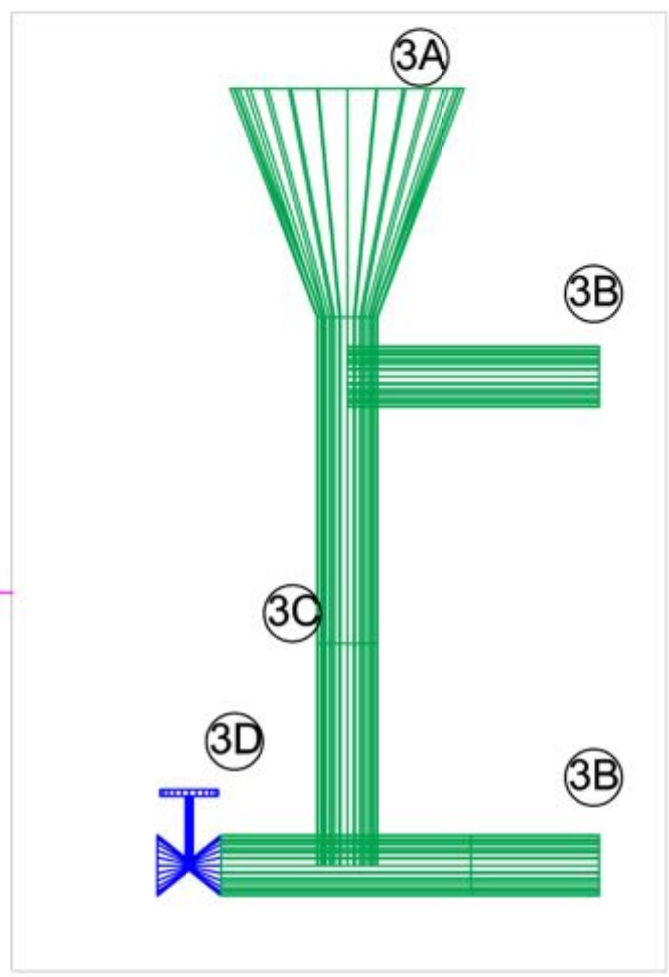



ARTICLE	QUANTITE'	DESCRIPTION	NOTES
3A	1	Entonnoir pour remplissage	
3B	2	Tuyau 1" 1/2	
2C	1	Tuyau 1" 1/2	
2D	1	Vanne 1" 1/2	

Itemref	Quantity	Title/Name, designation, material, dimension etc			Article No./Reference	
Designed by A. Carrea	Checked by E. Arato	Approved by - date Pongiglione - 30/06/08	File name Genvap	Date 30/06/08	Scale 1:6	
PS76 ONLUS		AMIGOS DA GUINE-BISSAU		Chaudière		
010-1-I-GDV-DGC-A				Edition 0	Sheet 8/9	

RevNo	Revision note	Date	Designed	Checked	Approved

NOTES GENERALES

1. Les dimensions non indiquées peuvent être obtenues à l'aide de l'échelle utilisée dans les différentes feuilles. Elles sont dans tous les cas indicatives et peuvent être modifiées par le fabricant pour faciliter la construction.
2. L'épaisseur des tuyaux est à la discrétion du fabricant

Itemref	Quantity	Title/Name, designation, material, dimension etc			Article No./Reference	
Designed by A. Carrea	Checked by E. Arato	Approved by - date Pongiglione - 30/06/08		File name Genvap	Date 30/06/08	Scale 1:6
 PS76 ONLUS			Chaudière			
				010-1-I-GDV-DGC-A	Edition 0	Sheet 9/9

1

4